



OneChipBook Series - 12

Technical Reference

Document Revision 1.0

Overview

The OneChipBook-12 is an FPGA development platform centered around the Cyclone EP1C12Q core. It integrates a VGA monitor, PS/2 mechanical keyboard, battery, and I/O ports. All peripheral devices are connected to the FPGA's general-purpose I/O pins, allowing users to control the entire system by developing for a single chip without complex interface design.

OneChipBook-12 has two order numbers. They share identical keyboard scan codes, with the only difference being the keyboard silkscreen markings.

- OneChipBook -12 (12k Les) -A (Keyboard layout A)
- B (Keyboard layout B)

Features

- FPGA: Cyclone EP1C12Q240
 - 12,060 Les
 - 239,616 bits RAM
- 32MB SDRAM
- 1024x768 VGA monitor
- VGA/S-Video/CVBS Output interface
- Mechanical keyboard (PS/2)/ Backlight
- Stereo speakers
- Type-C charging port
- Lithium battery
- Expansion Bus Support

Keyboard layout

- Keyboard layout A



- Keyboard layout B



External Interfaces

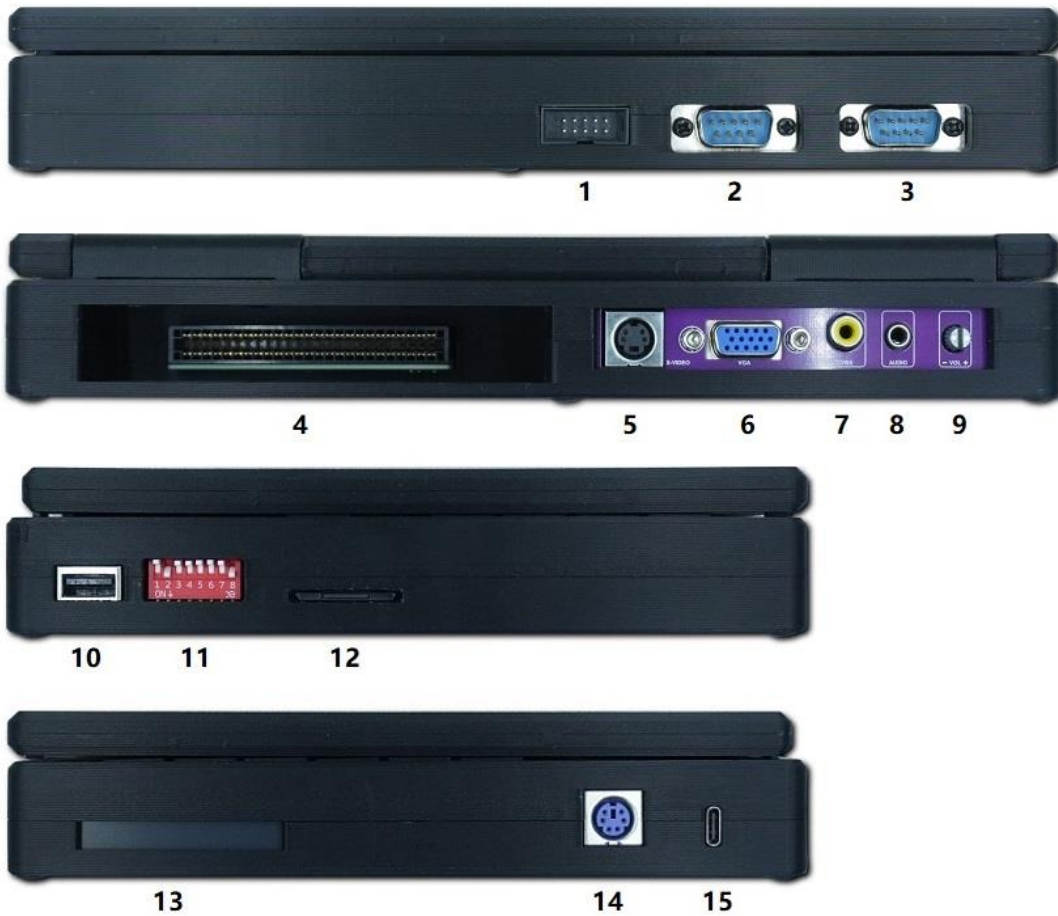

1. Firmware download port. (Active Serial Programming)
2. 1# DB9 Port
3. 2# DB9 Port
4. External expansion slot
5. S-Video interface
6. VGA interface
7. CVBS interface
8. Audio output jack
9. Volume control knob
10. USB port
11. Setting switch
12. SD card slot
13. Input/output window with built-in expansion card
14. PS/2 Keyboard port
15. Type-C charging port (5V-2A)

Motherboard

The OneChipBook-12's motherboard employs a four-layer PCB manufacturing process. Inside the device, there is an expansion interface that utilizes the same I/O as the external expansion slot, allowing users to design custom expansion modules and install them into the internally reserved space.

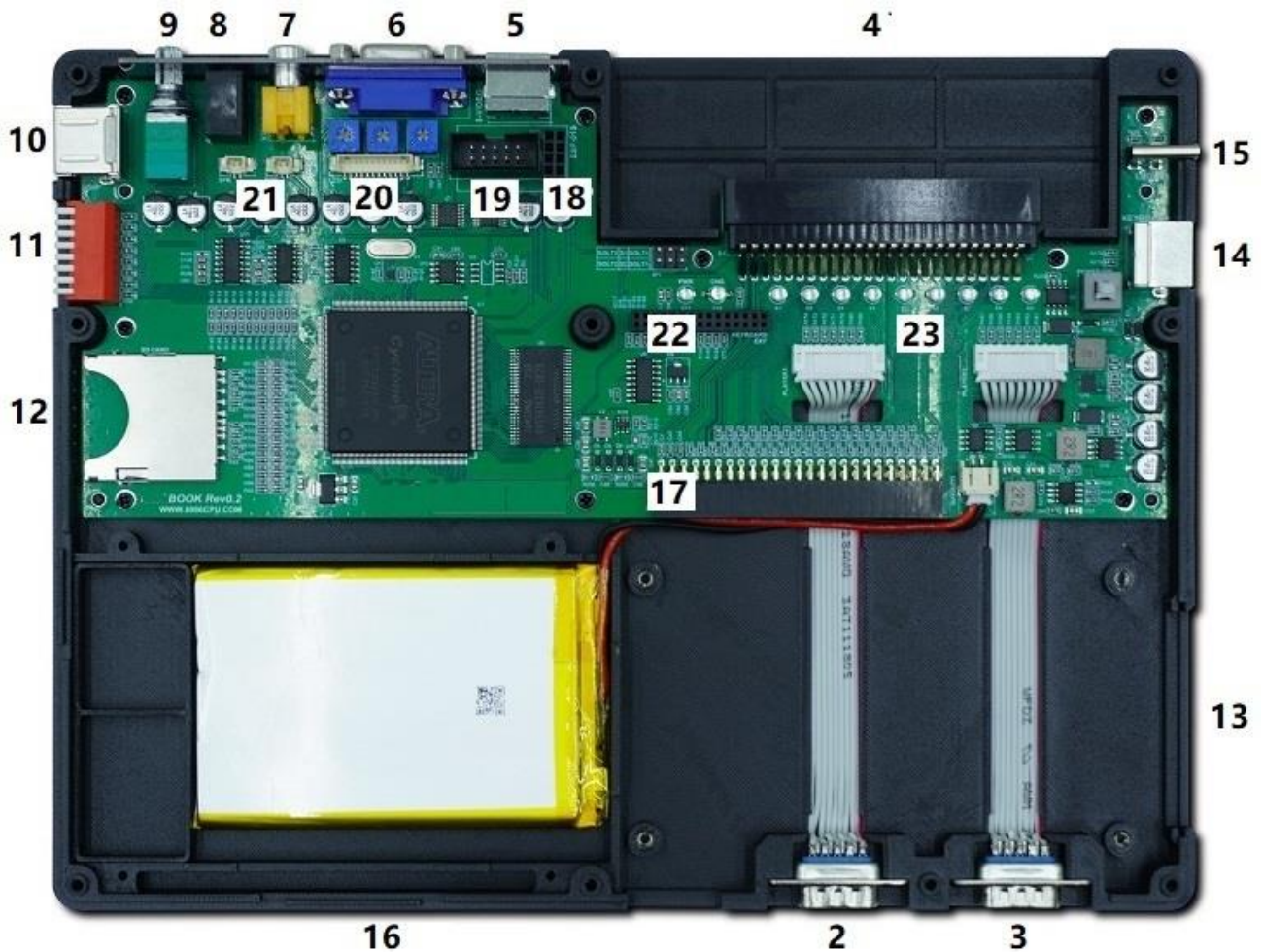

- 16. Battery compartment
- 17. Built-in expansion crad slot
- 18. Built-in module Interface
- 19. Firmware download port. (Active Serial Programming)
- 20. VGA monitor Interface
- 21. Speaker Interface
- 22. Built-in keyboard Interface
- 23. Status LED*9

Functional Description

1. Video / Audio / Keyboard

- The OneChipBook-12's LCD screen can be considered a built-in VGA monitor. It receives VGA signals, eliminating the need for users to manage LCD control. Whether the VGA signal is routed to the internal LCD monitor or the external VGA port is determined by a video toggle switch on the motherboard.
- The audio system consists of a D/A converter circuit, an amplifier, speakers, and output ports.
- The built-in keyboard is controlled by an MCU and outputs PS/2 protocol keyboard scan codes. It is connected in parallel with the external PS/2 port. To use an external PS/2 keyboard, the built-in keyboard can be disabled first. The integrated system of built-in keyboard → MCU → LCD operates independently of the FPGA, forming an On-Screen Display (OSD) system that provides users with fundamental keyboard and LCD configuration settings.

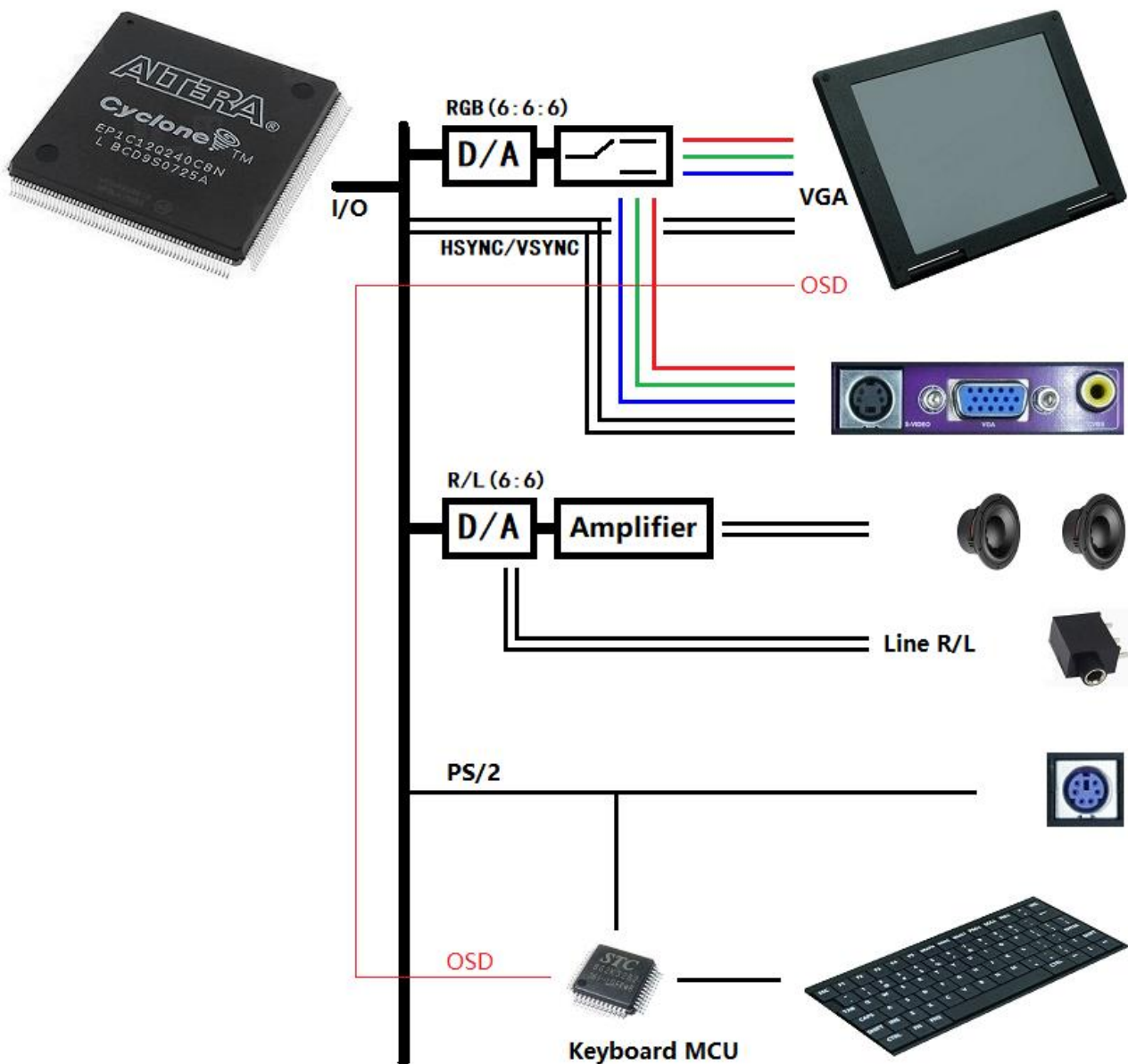

- Pin assignment:

VGA		RED		GREEN		BLUE	
	FPGA Pin	VR5	104	VG5	94	VB5	84
HSYNC	75	VR4	101	VG4	93	VB4	83
VSYNC	74	VR3	100	VG3	88	VB3	82
		VR2	99	VG2	87	VB2	79
		VR1	98	VG1	86	VB1	78
		VR0	95	VG0	85	VB0	77
PS2/Keyboard		Audio-R	FPGA Pin	Audio-L	FPGA Pin		
CLK	68	SR5	120	SL5	114		
DATA	67	SR4	119	SL4	113		
		SR3	118	SL3	108		
		SR2	117	SL2	107		
		SR1	116	SL1	106		
		SR0	115	SL0	105		

- Schematic diagram of the D/A converter circuit (VGA, S-Video, and Composite share these channels via multiplexing)

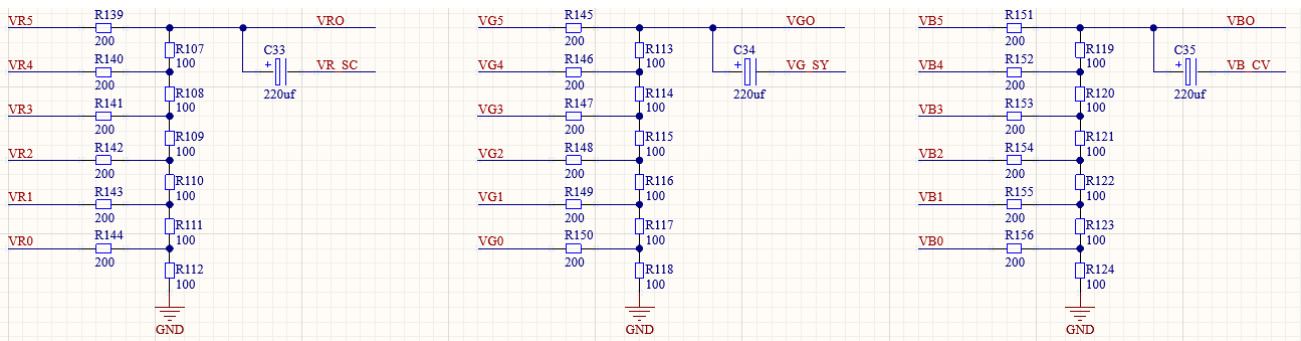

- The built-in keyboard allows redefinition of scan codes for the F7, INS, ALT, and RCTRL keys to accommodate diverse user needs (refer to the OSD section for configuration).

KEY	MAKE CODE	BREAK CODE	KEY	MAKE CODE	BREAK CODE	
A	1C	F0 1C	` ~	0E	F0 0E	
B	32	F0 32	- _	4E	F0 4E	
C	21	F0 21	= +	55	F0 55	
D	23	F0 23	\	5D	F0 5D	
E	24	F0 24	: ;	4C	F0 4C	
F	2B	F0 2B	' "	52	F0 52	
G	34	F0 34	, <	41	F0 41	
H	33	F0 33	. >	49	F0 49	
I	43	F0 43	/ ?	4A	F0 4A	
J	3B	F0 3B	[{	54	F0 54	
K	42	F0 42] }	5B	F0 5B	
L	4B	F0 4B	UP	E0 75	E0 F0 75	
M	3A	F0 3A	LEFT	E0 6B	E0 F0 6B	
N	31	F0 31	DOWN	E0 72	E0 F0 72	
O	44	F0 44	RIGHT	E0 74	E0 F0 74	
P	4D	F0 4D	PrintScreen	E0 12 E0 7C	E0 F0 7C E0 F0 12	
Q	15	F0 15	Scroll Lock	7E	F0 7E	
R	2D	F0 2D	LCTRL	14	F0 14	
S	1B	F0 1B	F1	05	F0 05	
T	2C	F0 2C	F2	06	F0 06	
U	3C	F0 3C	F3	04	F0 04	
V	2A	F0 2A	F4	0C	F0 0C	
W	1D	F0 1D	F5	03	F0 03	
X	22	F0 22	F6	0B	F0 0B	
Y	35	F0 35	F7	F7	83	F0 83
Z	1A	F0 1A		INS	E0 70	E0 F0 70
1	16	F0 16		HOME	E0 6C	E0 F0 6C
2	1E	F0 1E	F8	0A	F0 0A	
3	26	F0 26	F9	01	F0 01	
4	25	F0 25	F10	09	F0 09	
5	2E	F0 2E	F11	78	F0 78	
6	36	F0 36	INS	INS	E0 70	F0 E0 70
7	3D	F0 3D		F7	83	F0 83
8	3E	F0 3E		HOME	E0 6C	E0 F0 6C
9	46	F0 46		F6	0B	F0 0B
0	45	F0 45	F8	0A	F0 0A	
BACK	66	F0 66	ALT	ALT	11	F0 11
SPACE	29	F0 29		END	E0 69	E0 F0 69
TAB	0D	F0 0D		HOME	E0 6C	E0 F0 6C
CAPS	58	F0 58	RCTRL	CTRL	14	F0 14
SHIFT	12	F0 12		F7	83	F0 83
ENTER	5A	F0 5A		HOME	E0 6C	E0 F0 6C
DEL	E0 71	E0 F0 71		F6	0B	F0 0B
ESC	76	F0 76	F8	0A	F0 0A	

2. External expansion slot

The OneChipBook-12 features a 50-pin external expansion slot that can be used for circuit design extensions or expansion cartridges. This slot consists of:

- 42 general-purpose I/O pins
- 1 reset signal(active-low)
- Power supply lines

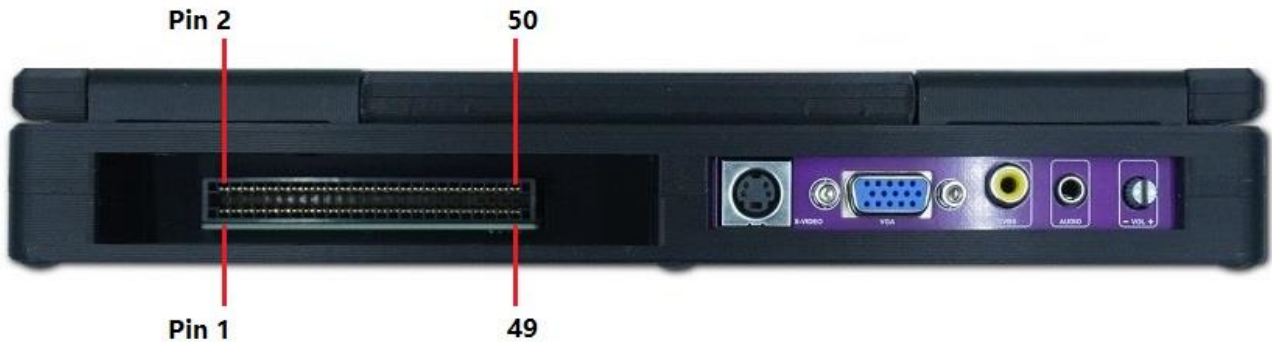

- Pin assignment:

	FPGA Pin			FPGA Pin	
IO	122	1	2	123	IO
IO	124	3	4	125	IO
IO	126	5	6	127	IO
IO	128	7	8	131	IO
IO	132	9	10	133	IO
IO	134	11	12	135	IO
IO	136	13	14	137	IO
RESET	153	15	16	138	IO
IO	139	17	18	140	IO
IO	141	19	20	143	IO
IO	156	21	22	158	IO
IO	159	23	24	160	IO
IO	161	25	26	162	IO
IO	163	27	28	164	IO
IO	165	29	30	166	IO
IO	167	31	32	168	IO
IO	169	33	34	170	IO
IO	173	35	36	174	IO
IO	175	37	38	176	IO
IO	177	39	40	178	IO
GND		41	42	144	IO
GND		43	44	179	IO
+5V		45	46	180	IO
+5V		47	48	+12V	
Audio-L		49	50	-12V	

- **Custom Slot Adapter:**

Users can provide us with the required pin count, specifications, power, and I/O layout configuration for the slot to customize the adapter. (Total usable I/O remains 43 pins.)

(Picture: Slot adapter appearance illustration)



- **Slot Adapter Usage Demonstration: Adapting to Different Cartridge Standards**

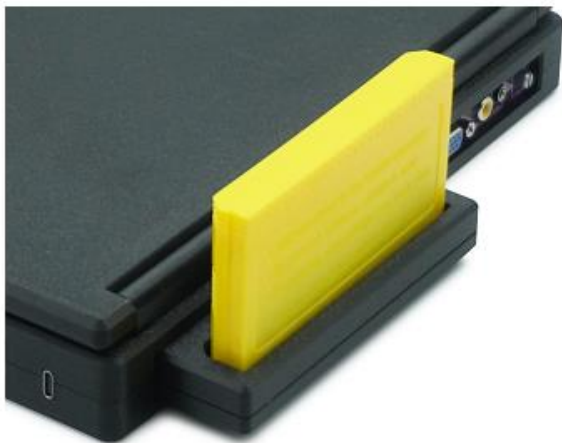

4. SDRAM

OneChipBook-12 is equipped with one SDRAM(32MB).

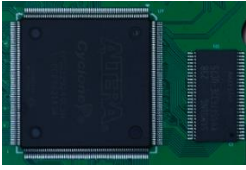

SDRAM pin assignment:

DRAM	FPGA Pin	DRAM	FPGA Pin	DRAM	FPGA Pin
D0	181	A0	203	RAS#	196
D1	182	A1	206	CAS#	195
D2	183	A2	207	CS#	197
D3	184	A3	208	LDQM	193
D4	185	A4	235	UDQM	223
D5	186	A5	234	CLK	38
D6	187	A6	233	CKE	39
D7	188	A7	228	WE#	194
D8	222	A8	227	BA0	200
D9	219	A9	226	BA1	201
D10	218	A10	202		
D11	217	A11	225		
D12	216	A12	224		
D13	215				
D14	214				
D15	213				

5. Internal Expansion Card Outline

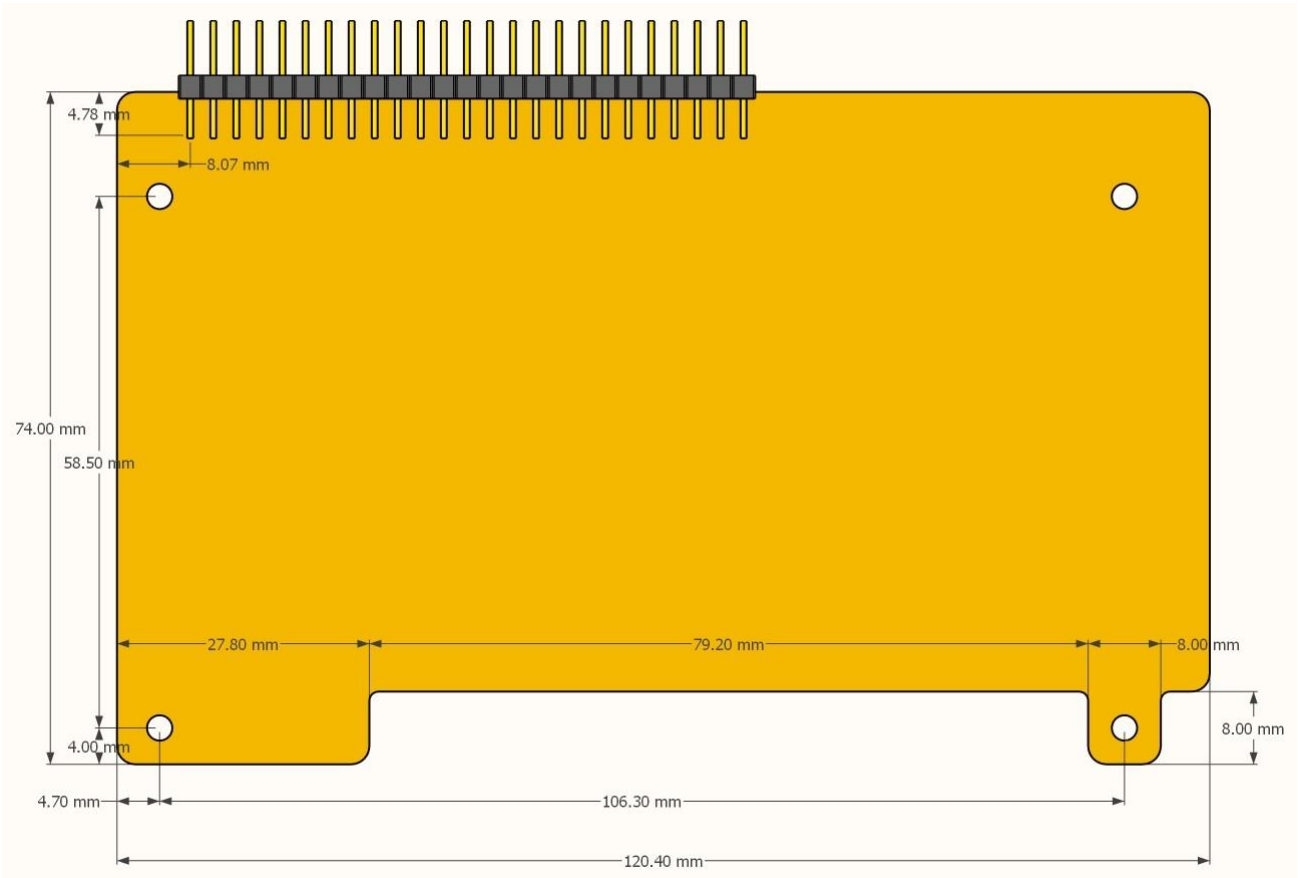

6. Keyboard Controller / OSD Settings

The built-in keyboard is controlled by an MCU. Its primary functions include managing the internal keyboard and transmitting keyboard scan codes to the FPGA. Through Fn key combinations, users can control various internal devices. The following lists the Fn key functions:

- FN+1: Switch between the built-in LCD and external VGA display
- FN+3: Turn the keyboard backlight on/off
- FN+4: Switch between the built-in keyboard and external PS/2 keyboard
- FN+F3: OSD - Custom Key Scan Code Configuration (press ESC to exit)
- FN+F4: OSD-LCD menu (press ESC to exit)
- FN+F5: OSD - System Status Menu (press ESC to exit)
- FN+R: Assert the RESET Signal (Active-Low)

Active Serial Programming Interface

The OneChipBook-12 provides an ASP interface on its front panel. Users can utilize a USB Blaster programmer (supporting Active Serial mode) to program the serial EEPROM.



Active Serial Programming			
1	DCLK	2	GND
3	C DONE	4	NC
5	n CONFIG	6	n CE
7	DATA in	8	n CS
9	DATA out	10	GND

The USB Blaster included in the package is a simplified version and is intended solely as a spare/backup unit.



(Simplified USB Blaster)

We recommend using the Intel® FPGA Download Cable.
(Ordering Part Number: PL-USB-BLASTER-RCN).



(Intel® FPGA Download Cable)

Suggested Reference Material

- Cyclone FPGA Family Data Sheet
- Quartus II Handbook Version 9.0
- Intel® FPGA Download Cable User Guide

Schematic diagram

